

[www.advance-e.jp](http://www.advance-e.jp)

High Temperature Type

# NEW SAV series

Pneumatically Actuated DIW / Chemical Valves

**ADVANCE** ELECTRIC CO., INC.

519-1, Urayashiki, Hazama-Cho, Kasugai-Shi, Aichi, 487-0031 Japan PHONE: +81-568-88-7300 FAX: +81-568-88-7373

**ADVANCE**<sup>®</sup>

PRODUCT CATALOG Valves for a multiplicity of requirements

[www.advance-e.jp](http://www.advance-e.jp)

S-E1602A

# INDEX

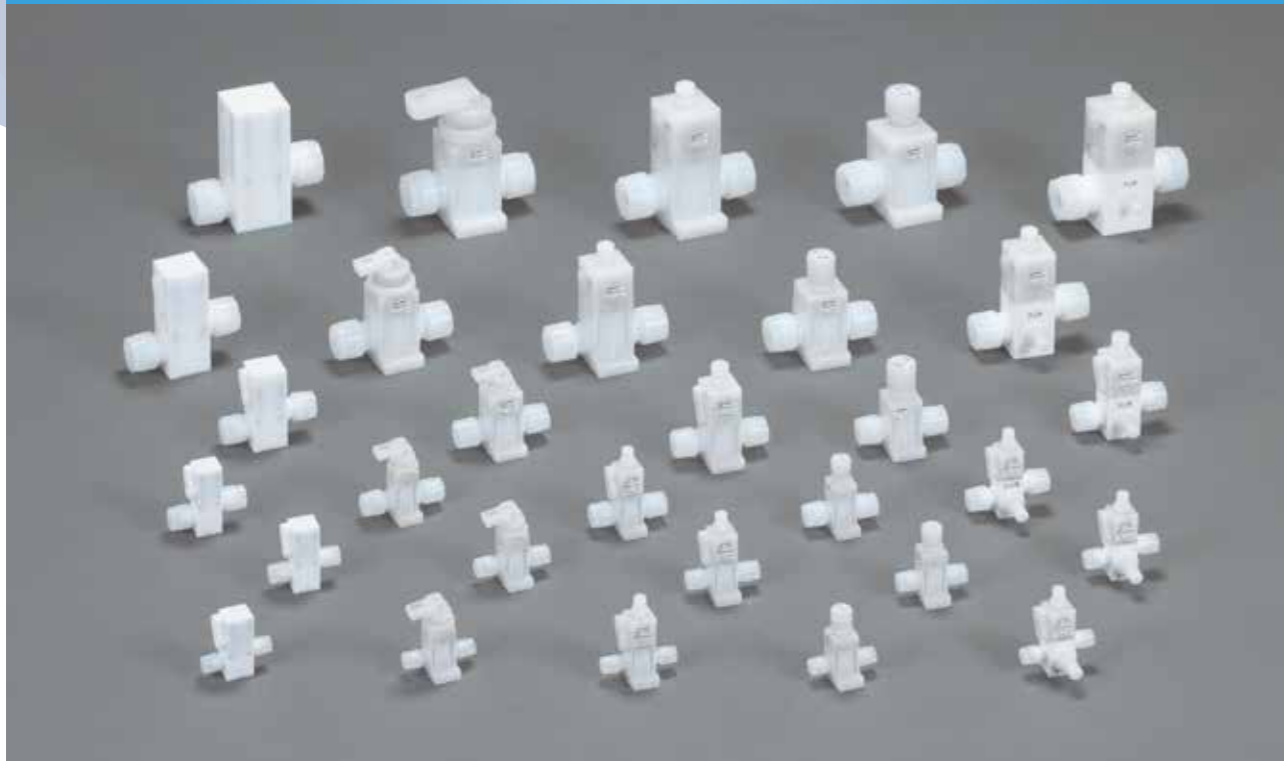

## NEW SAV (High Temperature Type) series

Pneumatically Actuated DIW / Chemical Valves

N*2100-2A/6MCB-*SH .....	02-03
N*2100-8MCB-*SH .....	04-05
N*2100-3/10MCB-*SH .....	06-07
N*3100-4/12MCB-*SH .....	08-09
N*4100-6/19MCB-*SH .....	10-11
N*6100-8/25MCB-*SH .....	12-13

High Temperature Type

# NEW SAV series

Pneumatically Actuated DIW / Chemical Valve

Driven by a pneumatic actuator (cylinder) the New SAV series pneumatic valves open and close by air operation.

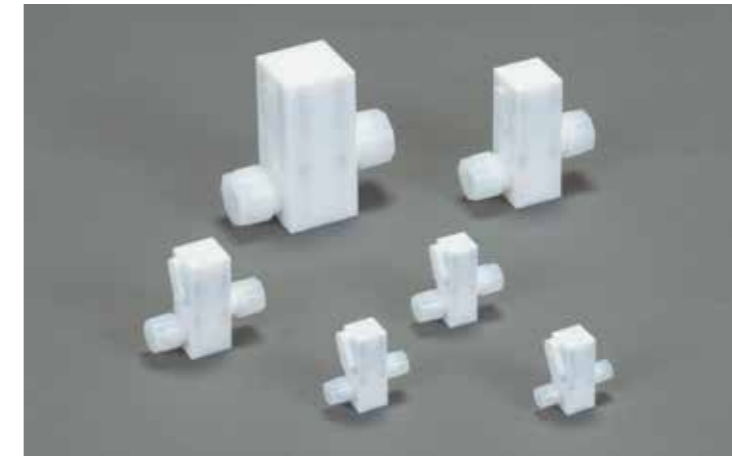

## Export Control

●Export control is aimed at preventing the proliferation of weapons of mass destruction and other sensitive items to countries and regions of security concern or terrorist organizations. Export transactions of goods and technology that have potential weapons of mass destruction (WMD)/ conventional weapons applications are regulated under laws and regulations.

●To ensure safety by maintaining international peace and security, a license may be required from governmental authorities in order to export or provide products or technologies within this catalog. The regulation for export of cargos and technologies is defined by the following four regimes as well as governmental authorities of each country.

Nuclear Suppliers Group (NSG)  
Australia Group (AG)

Missile Technology Control Regime (MTCR)  
Wassenaar Arrangement (WA)

●Be sure to comply with each country's export control laws and regulations when exporting or providing products or technologies within this catalog.

※Please contact us if you have any questions.

High Temperature Type  
Pneumatically Actuated DIW / Chemical Valve  
**N\*2100-2A/6MCB-\*SH**



Dimensional Drawing

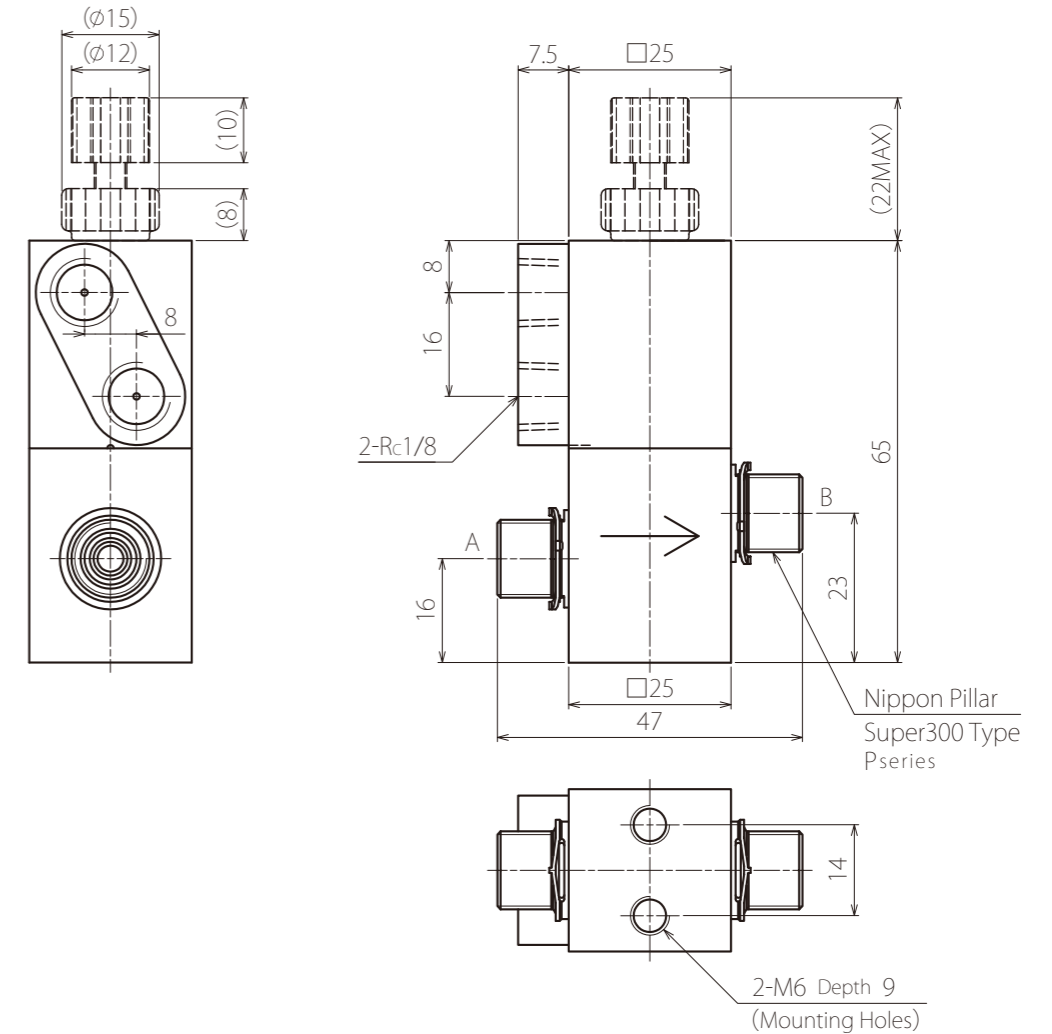

Specifications

Model Code	See Model Selection Table
Orifice Size	φ4 [mm]
Connection Size	See Model Selection Table
Cv	0.32
Applicable Media	DI Water, Corrosive Fluid
Media Pressure	A→B: 0~0.3MPa *1 B→A: 0~0.3MPa *1
Media Temperature	10~200°C *1
Ambient Temperature	10~80°C
Operational Mode	Spring Return (Single-acting Type)
Pneumatic Pressure	0.38~0.5MPa
Wetted Material	Diaphragm: PTFE Valve Body: PTFE

\*1 See the right graph for details. \*Specifications are subject to change without notice.

Model Selection Table

**N\*2100-\*CB-\*SH**

Standard Option  
Z: with Flow Adjuster

Connection Size  
2A: (I.D.×O.D.)3.97×6.35 [mm]  
6M: (I.D.×O.D.)4×6 [mm]

C: NC (Normally Closed)  
O: NO (Normally Open)

(unit : mm)

Media Pressure vs. Media Temperature  
(A→B/B→A)

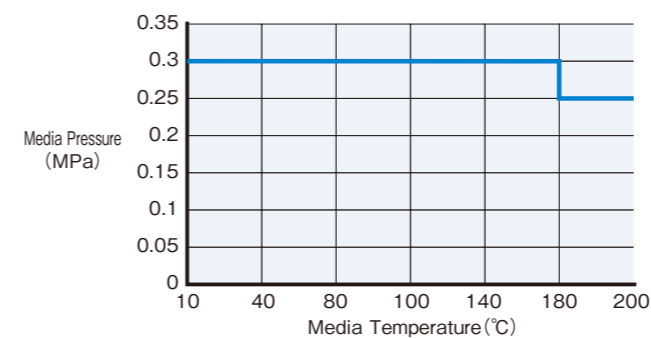

Flow Characteristics Cv:0.32

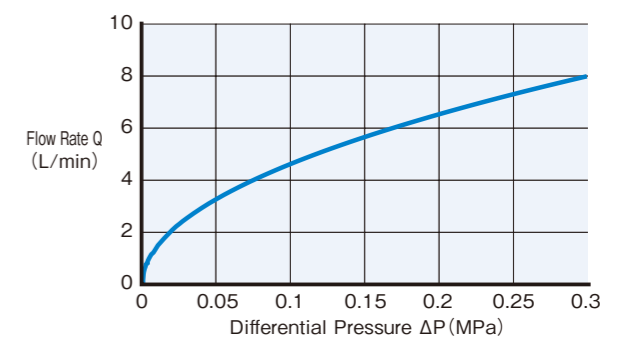

High Temperature Type

Pneumatically Actuated DIW / Chemical Valve

# N\*2100-8MCB-\*SH



Dimensional Drawing

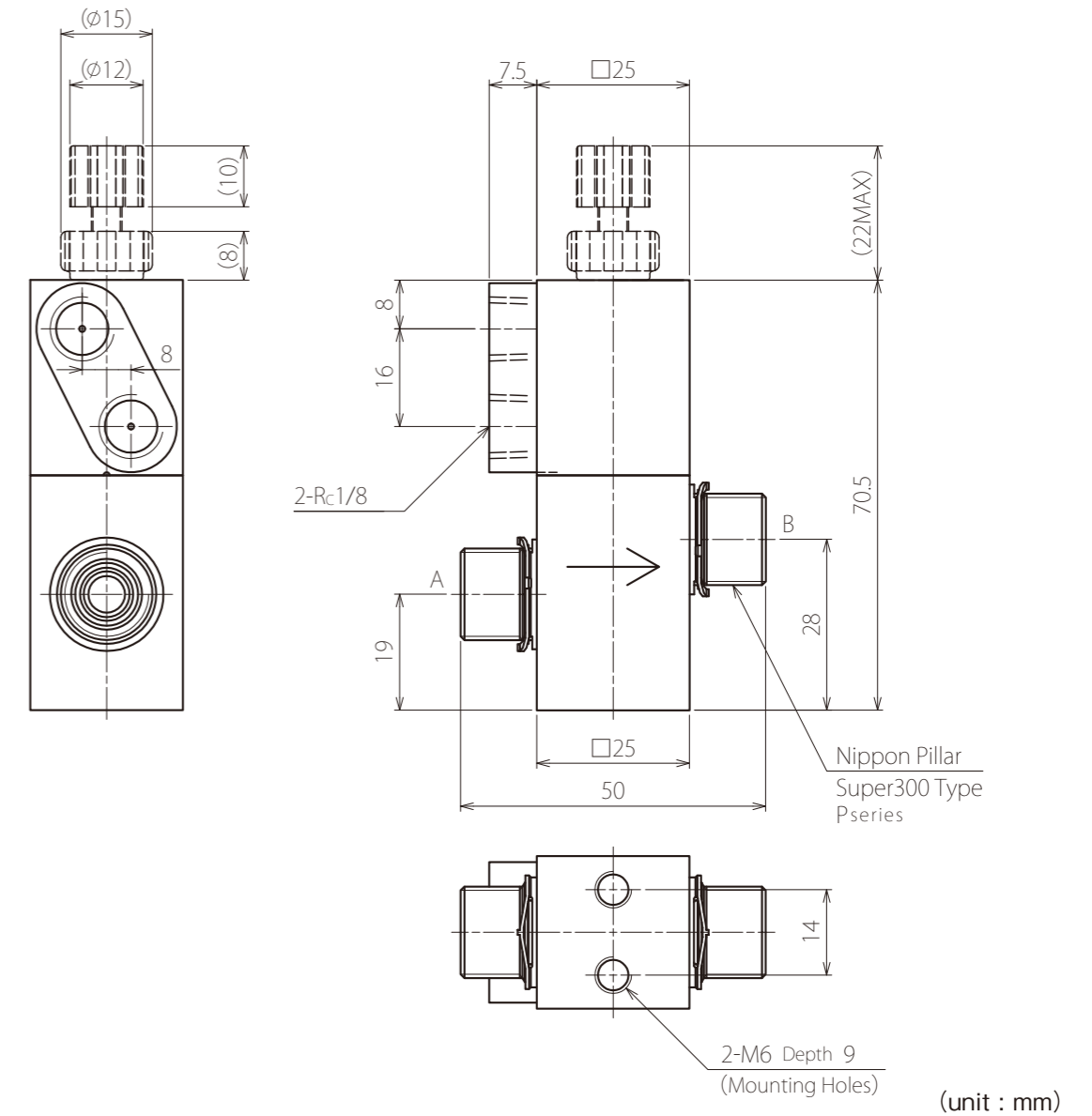

Specifications

Model Code	See Model Selection Table
Orifice Size	φ6[mm]
Connection Size	See Model Selection Table
Cv	0.84
Applicable Media	DI Water, Corrosive Fluid
Media Pressure	A→B: 0~0.3MPa *1 B→A: 0~0.3MPa *1
Media Temperature	10~200°C *1
Ambient Temperature	10~80°C
Operational Mode	Spring Return (Single-acting Type)
Pneumatic Pressure	0.38~0.5MPa
Wetted Material	Diaphragm: PTFE Valve Body: PTFE

Model Selection Table

## N\*2100-8MCB-\*SH

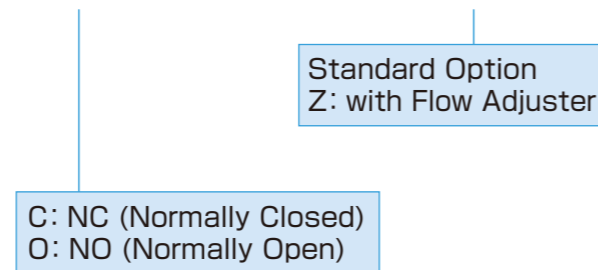

Media Pressure vs. Media Temperature (A→B/B→A)

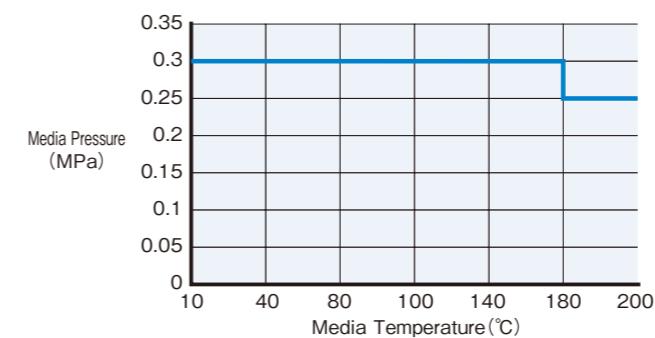

Flow Characteristics Cv:0.84

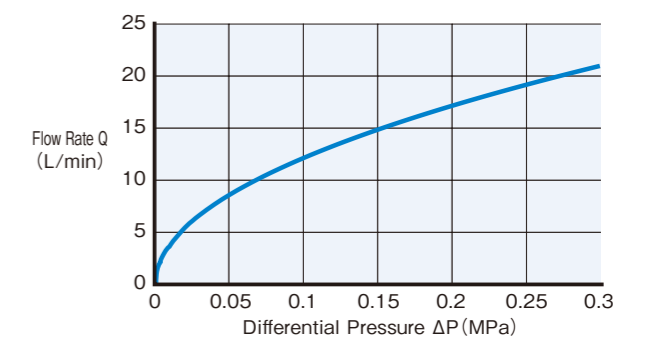

\*1 See the right graph for details. \*Specifications are subject to change without notice.

High Temperature Type

Pneumatically Actuated DIW / Chemical Valve

# N\*2100-3/10MCB-\*SH



Dimensional Drawing

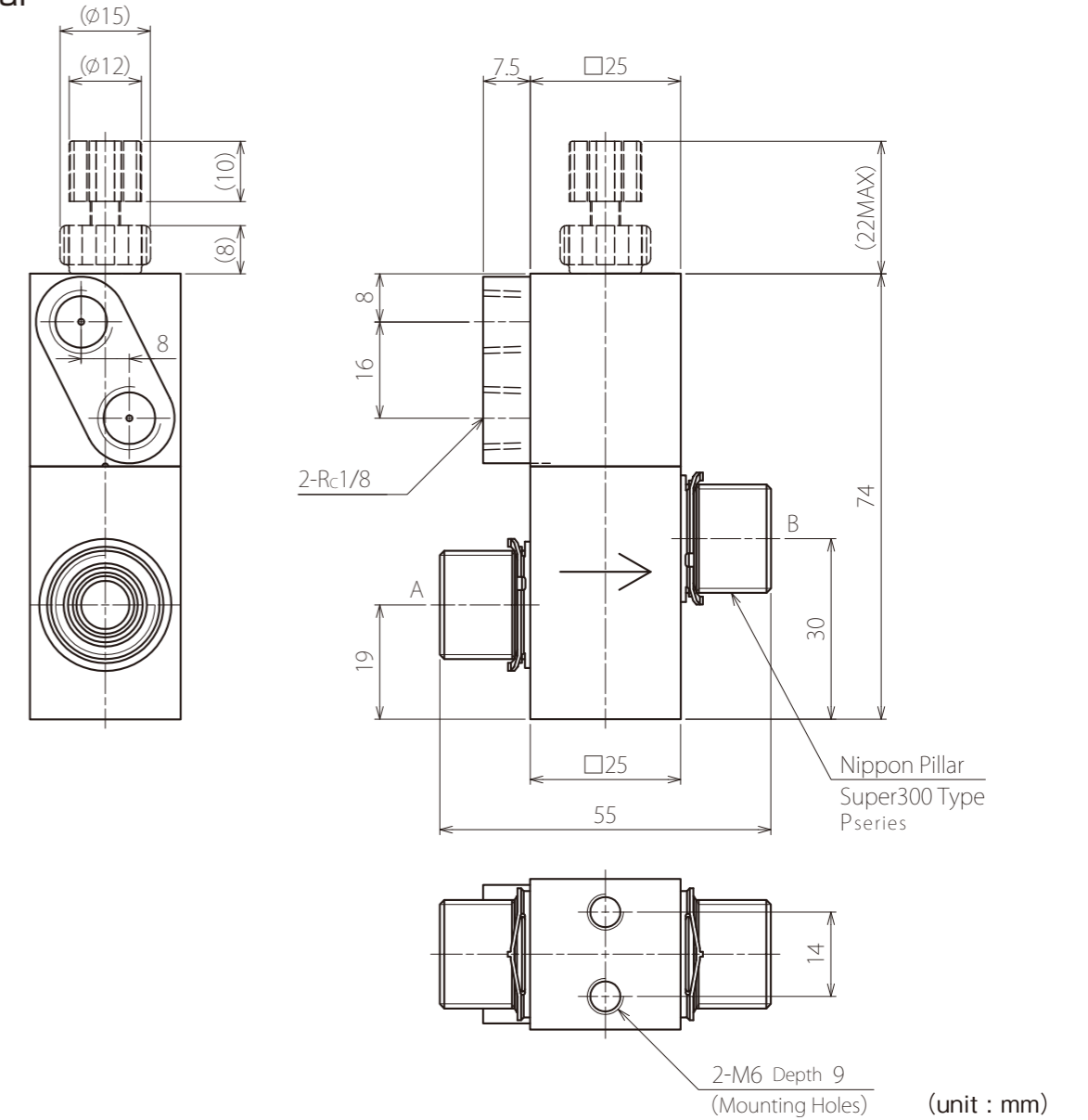

Specifications

Model Code	See Model Selection Table
Orifice Size	φ6[mm]
Connection Size	See Model Selection Table
Cv	0.86
Applicable Media	DI Water, Corrosive Fluid
Media Pressure	A→B: 0~0.3MPa *1 B→A: 0~0.3MPa *1
Media Temperature	10~200°C *1
Ambient Temperature	10~80°C
Operational Mode	Spring Return (Single-acting Type)
Pneumatic Pressure	0.38~0.5MPa
Wetted Material	Diaphragm: PTFE Valve Body: PTFE

\*1 See the right graph for details. \*Specifications are subject to change without notice.

Model Selection Table

## N\*2100-\*CB-\*SH

Standard Option  
Z: with Flow Adjuster

Connection Size  
3: (I.D.×O.D.)6.35×9.53[mm]  
10M: (I.D.×O.D.)8×10[mm]

C: NC (Normally Closed)  
O: NO (Normally Open)

Media Pressure vs. Media Temperature (A→B/B→A)

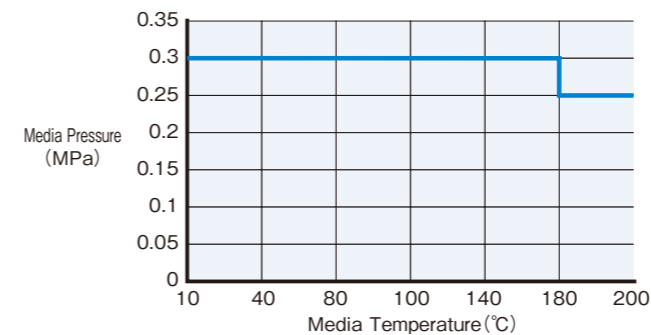

Flow Characteristics Cv:0.86

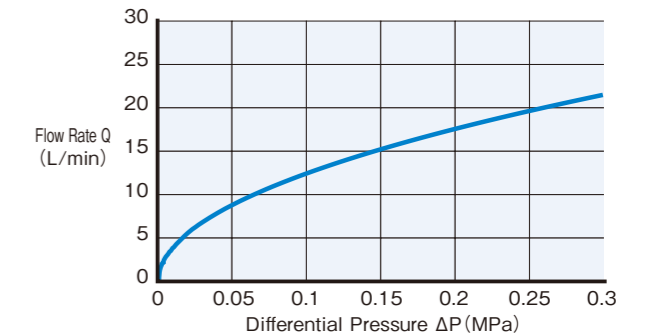

High Temperature Type

Pneumatically Actuated DIW / Chemical Valve

# N\*3100-4/12MCB-\*SH

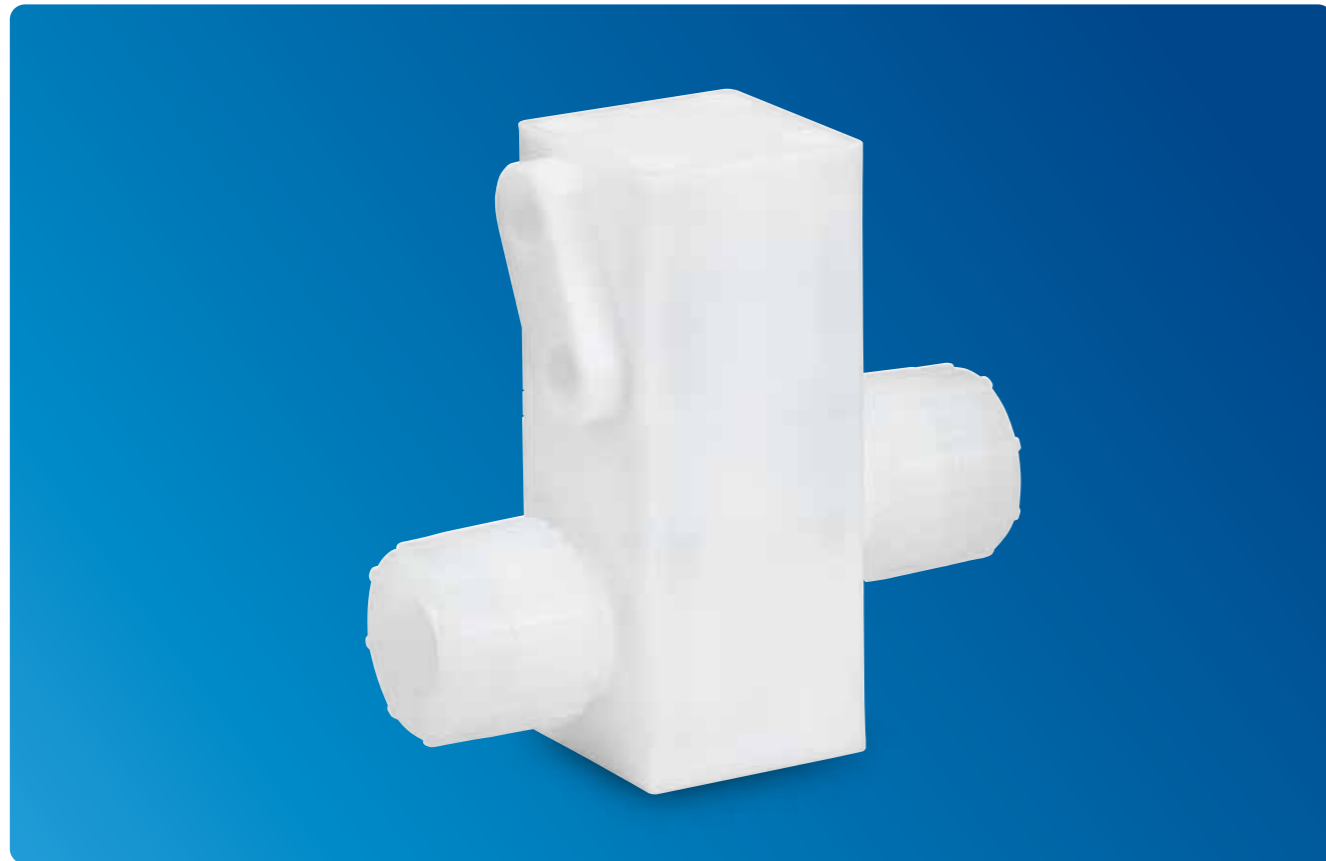

Dimensional Drawing

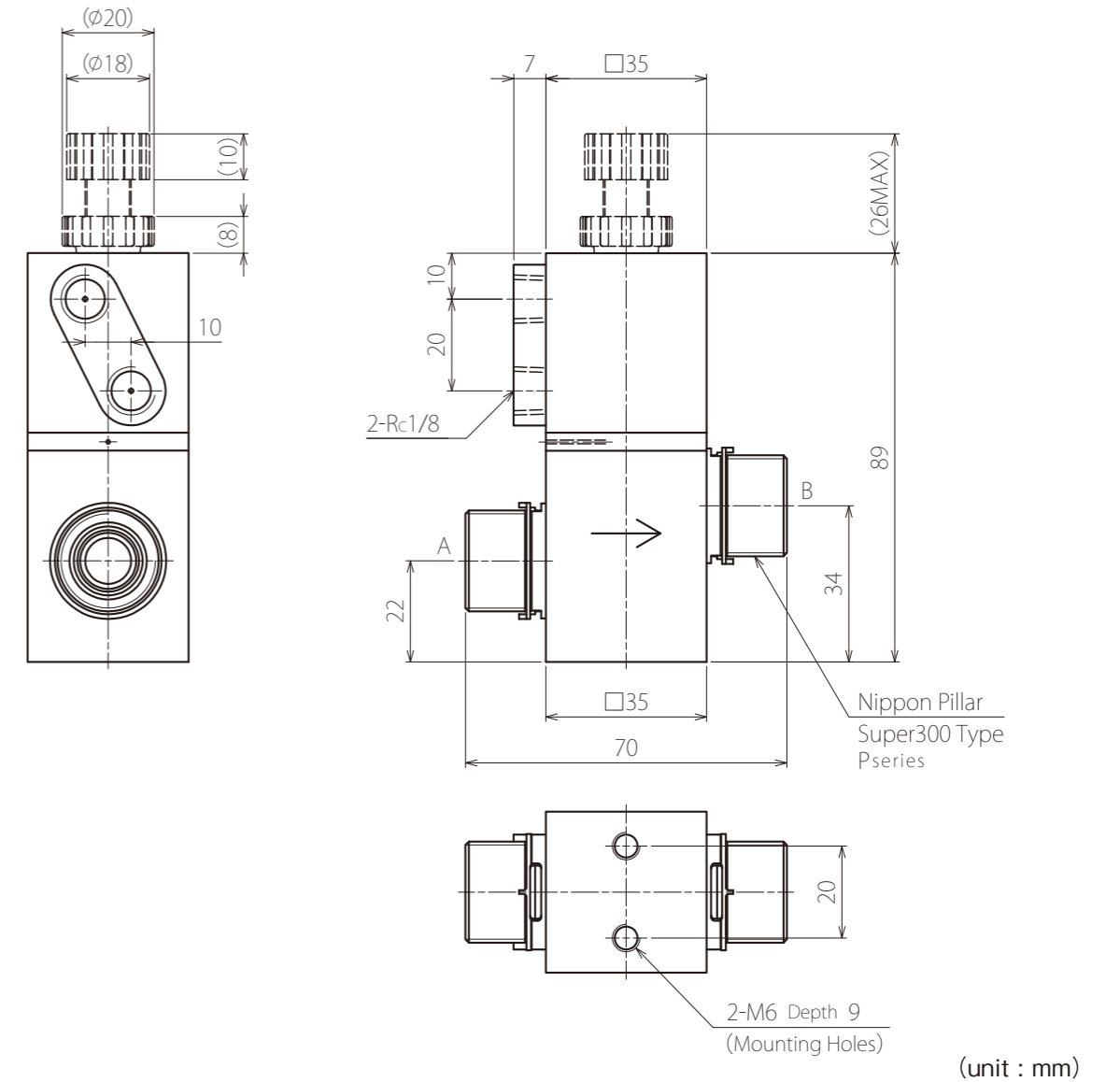

Specifications

Model Code	See Model Selection Table
Orifice Size	φ10 [mm]
Connection Size	See Model Selection Table
Cv	2.0
Applicable Media	DI Water, Corrosive Fluid
Media Pressure	A→B: 0~0.3MPa *1 B→A: 0~0.3MPa *1
Media Temperature	10~200°C *1
Ambient Temperature	10~80°C
Operational Mode	Spring Return (Single-acting Type)
Pneumatic Pressure	0.38~0.5MPa
Wetted Material	Diaphragm: PTFE Valve Body: PTFE

\*1 See the right graph for details. \*Specifications are subject to change without notice.

Model Selection Table

## N\*3100-\*CB-\*SH

Standard Option  
Z: with Flow Adjuster

Connection Size  
4: (I.D.×O.D.) 9.53×12.7 [mm]  
12: (I.D.×O.D.) 10×12 [mm]

C: NC (Normally Closed)  
O: NO (Normally Open)

Media Pressure vs. Media Temperature (A→B/B→A)

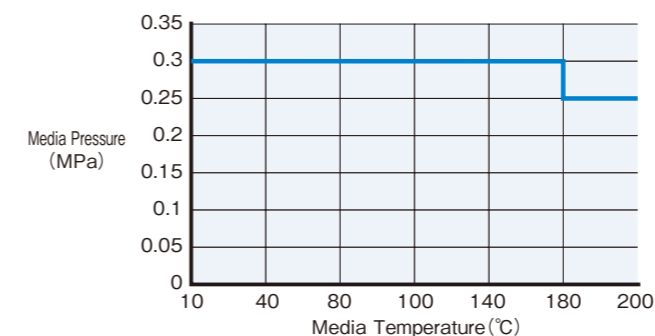

Flow Characteristics Cv:2.0

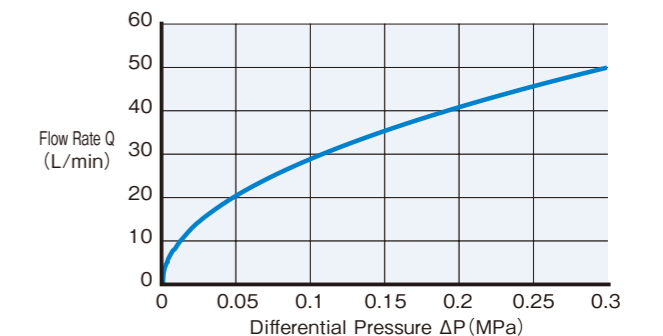

High Temperature Type

Pneumatically Actuated DIW / Chemical Valve

# N\*4100-6/19MCB-\*SH

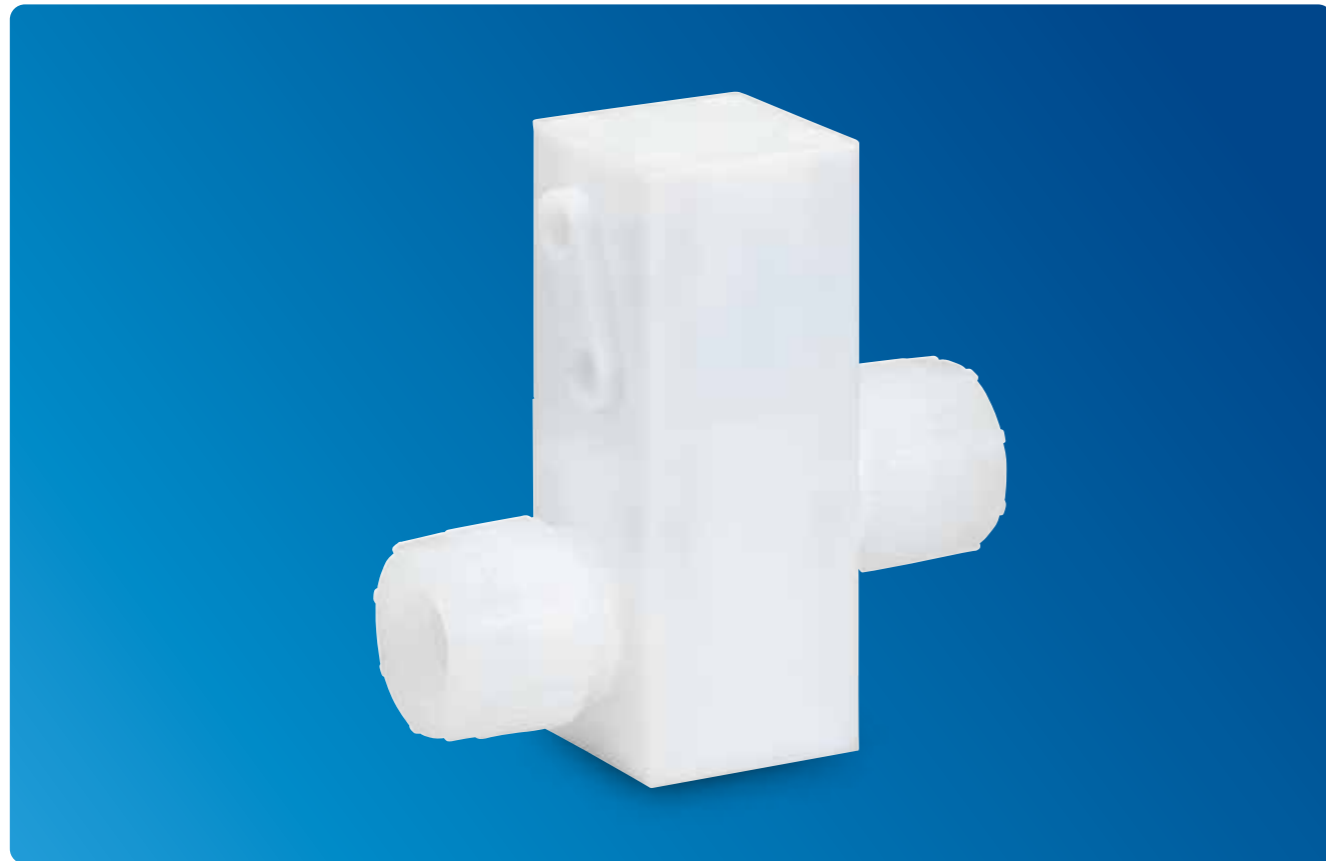

Dimensional Drawing

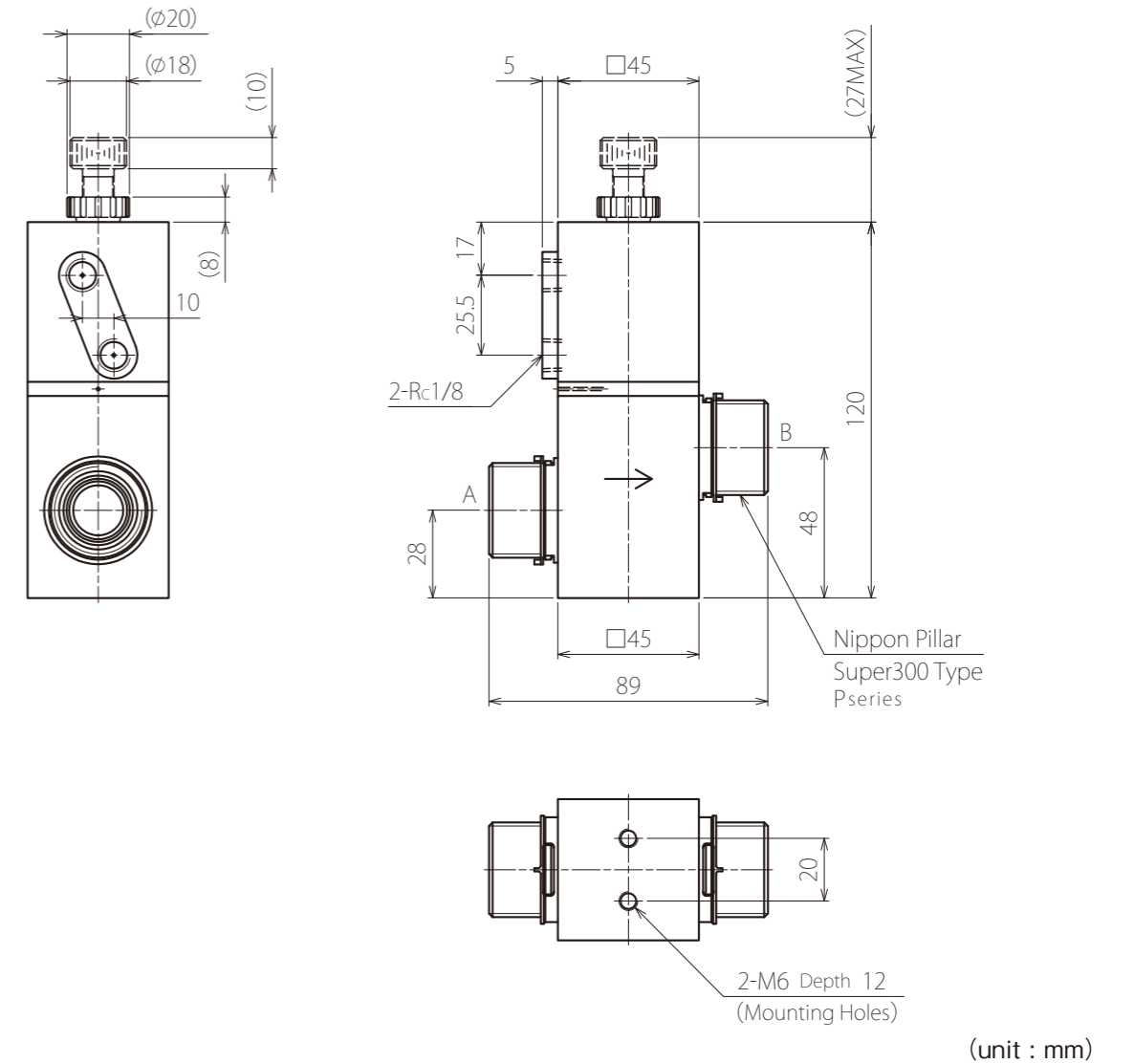

Specifications

Model Code	See Model Selection Table
Orifice Size	φ16 [mm]
Connection Size	See Model Selection Table
Cv	6.1
Applicable Media	DI Water, Corrosive Fluid
Media Pressure	A→B: 0~0.3MPa *1 B→A: 0~0.3MPa *1
Media Temperature	10~200°C *1
Ambient Temperature	10~80°C
Operational Mode	Spring Return (Single-acting Type)
Pneumatic Pressure	0.38~0.5MPa
Wetted Material	Diaphragm: PTFE Valve Body: PTFE

\*1 See the right graph for details. \*Specifications are subject to change without notice.

Model Selection Table

## N\*4100-\*CB-\*SH

Standard Option  
Z: with Flow Adjuster

Connection Size  
6: (I.D.×O.D.) 15.88×19.05 [mm]  
19M: (I.D.×O.D.) 16×19 [mm]

C: NC (Normally Closed)  
O: NO (Normally Open)

Media Pressure vs. Media Temperature (A→B/B→A)

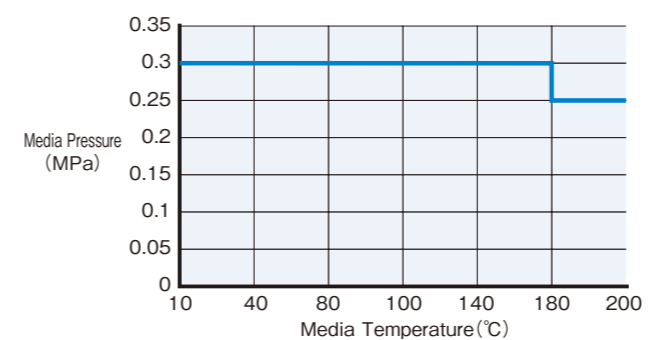

Flow Characteristics Cv:6.1

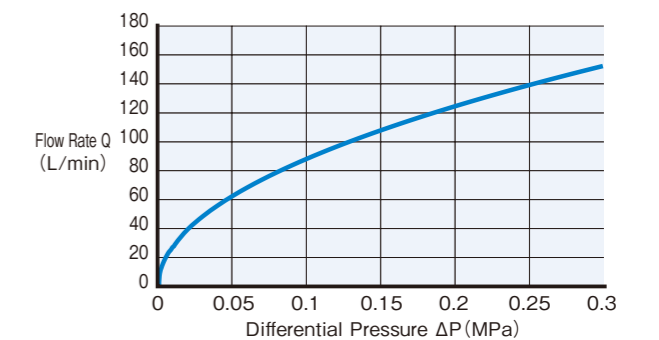

High Temperature Type

Pneumatically Actuated DIW / Chemical Valve

# N\*6100-8/25MCB-\*SH



Dimensional Drawing

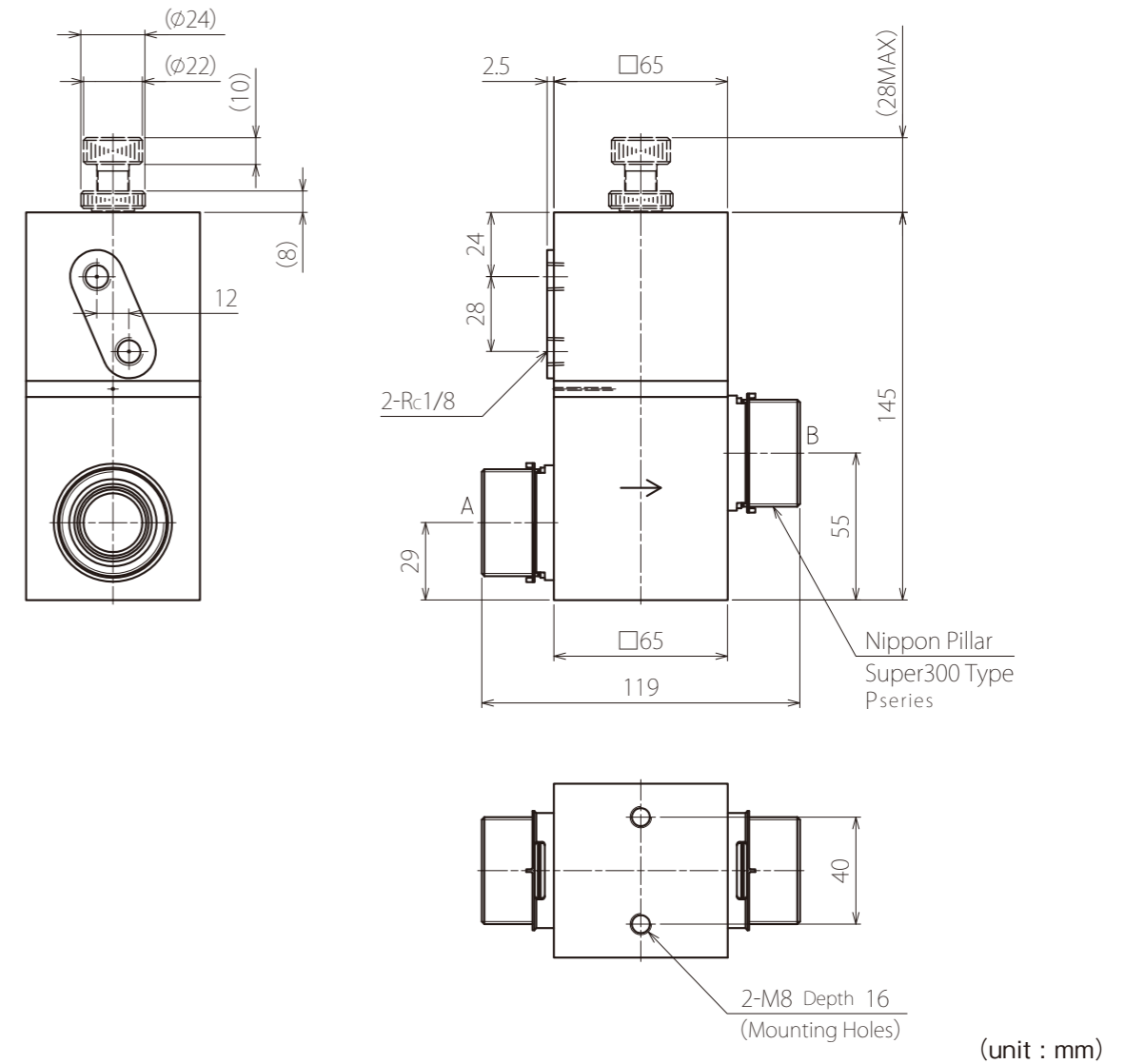

Specifications

Model Code	See Model Selection Table
Orifice Size	φ22 [mm]
Connection Size	See Model Selection Table
Cv	11.0
Applicable Media	DI Water, Corrosive Fluid
Media Pressure	A→B: 0~0.3MPa *1 B→A: 0~0.3MPa *1
Media Temperature	10~200°C *1
Ambient Temperature	10~80°C
Operational Mode	Spring Return (Single-acting Type)
Pneumatic Pressure	0.38~0.5MPa
Wetted Material	Diaphragm: PTFE Valve Body: PTFE

\*1 See the right graph for details. \*Specifications are subject to change without notice.

Model Selection Table

## N\*6100-\*CB-\*SH

Standard Option  
Z: with Flow Adjuster

Connection Size  
8: (I.D.×O.D.)22.23×25.4 [mm]  
25M: (I.D.×O.D.)22×25 [mm]

C: NC (Normally Closed)  
O: NO (Normally Open)

Media Pressure vs. Media Temperature (A→B/B→A)

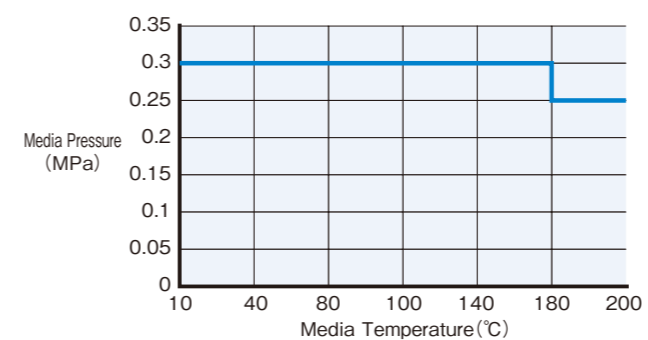

Flow Characteristics Cv:11.0

